



# DJCONTROL IMPULSE 200 MK2

## User Manual



# TABLE OF CONTENTS

<b>1.</b>	<b>BOX CONTENTS .....</b>	<b>5</b>
<b>2.</b>	<b>TECHNICAL SPECIFICATIONS .....</b>	<b>6</b>
<b>3.</b>	<b>FEATURES .....</b>	<b>7</b>
	<i>Overview.....</i>	<i>7</i>
	<i>Decks .....</i>	<i>8</i>
	<i>Mixing .....</i>	<i>18</i>
	<i>Connectors.....</i>	<i>26</i>
<b>4.</b>	<b>INSTALLATION.....</b>	<b>27</b>
	<i>Connections.....</i>	<i>27</i>
	<i>Downloading the software .....</i>	<i>29</i>
	<i>DJUCED® .....</i>	<i>29</i>
	<i>Serato DJ Lite.....</i>	<i>32</i>
<b>5.</b>	<b>LIVENING UP YOUR MIX .....</b>	<b>34</b>
	<i>Modes and pads .....</i>	<i>34</i>
	<i>The pads .....</i>	<i>34</i>
	<i>Hot Cue mode .....</i>	<i>35</i>
	<i>Stems mode .....</i>	<i>36</i>

	<i>FX mode</i> .....	37
	<i>Sampler mode</i> .....	39
	<b><i>Scratching</i></b> .....	<b>40</b>
	<b><i>Filters</i></b> .....	<b>41</b>
<b>6.</b>	<b>MULTICHANNEL SOUND CARD</b> .....	<b>42</b>
	<b><i>Master output for speakers (output 1-2)</i></b> .....	<b>42</b>
	<b><i>Headphones output (output 3-4)</i></b> .....	<b>43</b>
<b>7.</b>	<b>COMPATIBILITY</b> .....	<b>44</b>
	<b><i>USB Audio / USB MIDI</i></b> .....	<b>44</b>
	<b><i>ASIO and Windows® control panel</i></b> .....	<b>44</b>
	<b><i>Firmware update</i></b> .....	<b>47</b>
<b>8.</b>	<b>DEMO MODE</b> .....	<b>48</b>
<b>9.</b>	<b>FAQS</b> .....	<b>49</b>



# DJCONTROL IMPULSE 200 MK2

Hercules DJControl Impulse 200 MK2 is a full-featured controller designed for getting started DJing thanks to dedicated features, video tutorials and integration with the DJUCED<sup>®</sup> and Serato DJ Lite software.



Hercules DJControl Impulse 200 MK2 includes a license for Serato DJ Lite, not a license for Serato DJ Pro. If you install Serato DJ Pro instead of Serato DJ Lite, Serato DJ Pro will work with your DJControl Impulse 200 MK2 for the duration of a trial period. At the end of this trial period, if you want to continue using Serato DJ Pro, you must purchase a Serato DJ Pro license.



## 1. Box contents

- Hercules DJControl Inpulse 200 MK2
- Hercules, Serato and DJUCED® stickers
- Warranty flyer

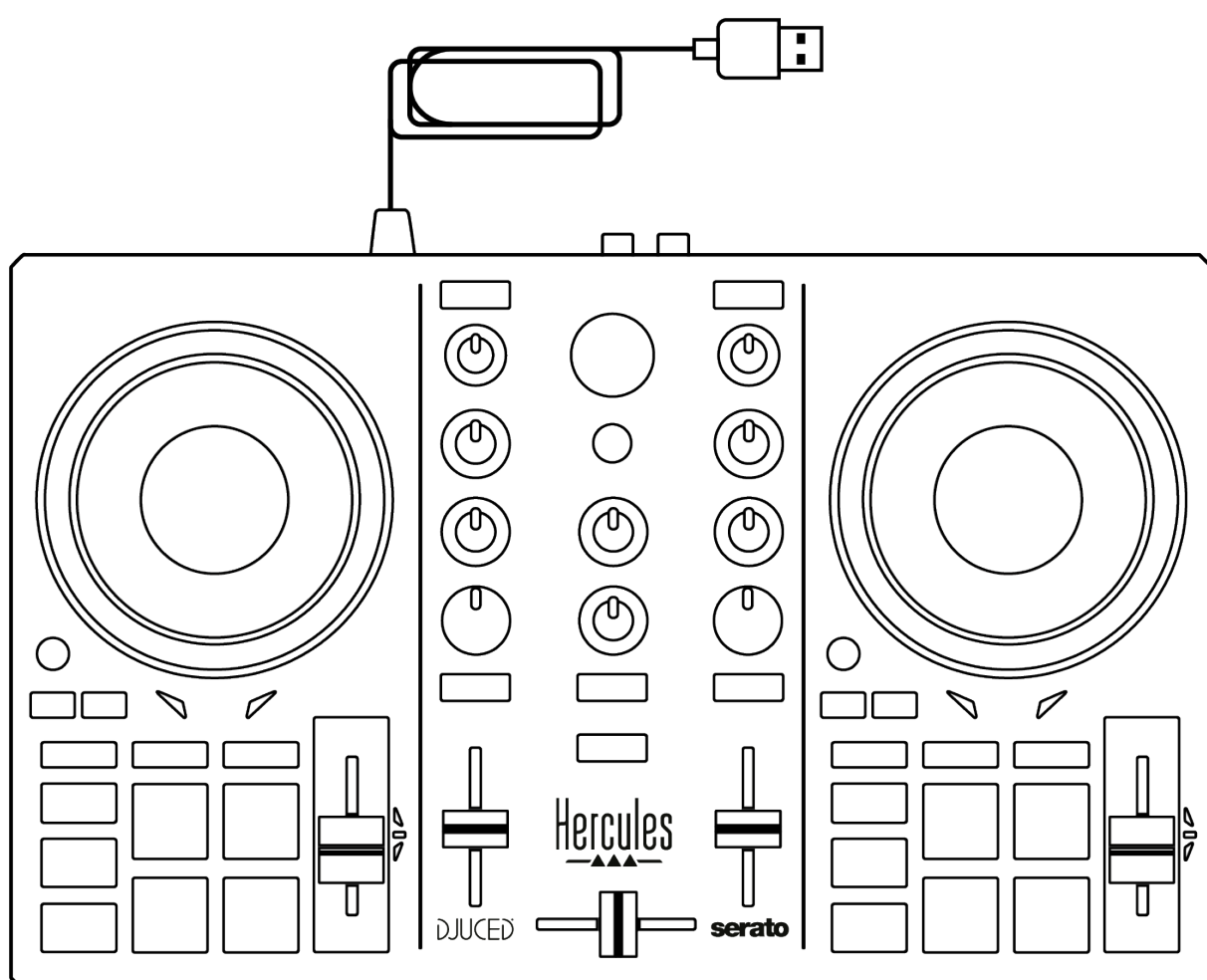

You can remove the protective film covering the VU meter on the Hercules DJControl Inpulse 200 MK2 controller. You can also leave the protective film in place, as it does not affect the use of the VU meter.



## 2. Technical specifications

System requirements:

- DJUCED®:

<https://www.djuced.com/downloadaddjuced/>

- Serato DJ Lite:

<https://serato.com/dj/lite/downloads?systemrequirements#system-requirements>

Master output for speakers (output 1-2) via two RCA connectors:

- Maximum output power = 5 dBu @ 1 kΩ
- THD+N @1 kHz < 0.01%
- Resolution = 24-bit
- Sample rate = 44.1 kHz

Headphones output (output 3-4) via one 3.5 mm stereo mini-jack connector:

- Maximum output power = 5 dBu for 32Ω @ 1 kHz
- THD+N @1kHz < 0.017%
- Resolution = 24-bit
- Sample rate = 44.1 kHz



## 3. Features

### Overview

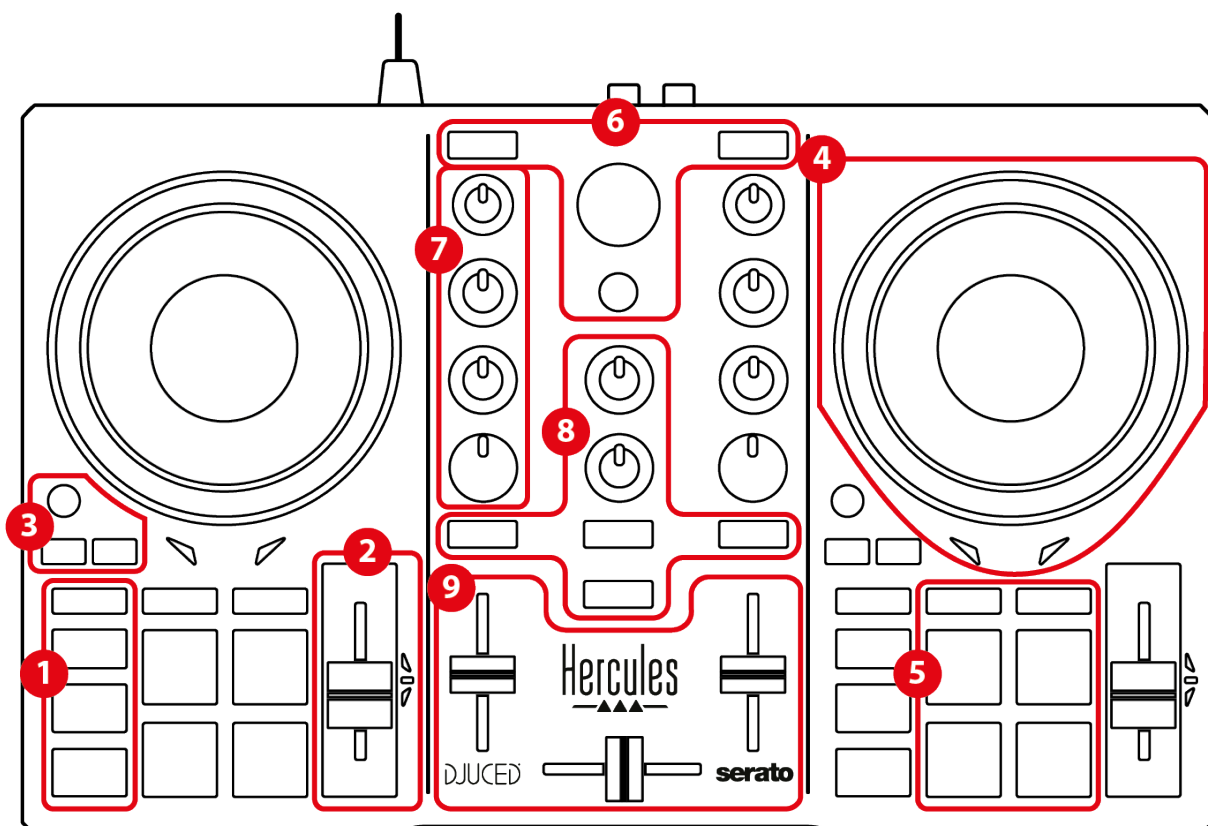

1. Transport buttons (Play, Cue, Sync, Shift)
2. Tempo fader (Pitch fader)
3. Loop controls (Loop)
4. Jog wheel
5. Pads and modes
6. Track selection controls (Browser, Load, Assist./Prep.)
7. Mixing section (Gain, EQ, Filter)
8. Monitoring, volumes (Master and Headphones) and Beatmatch Guide
9. Mixer (Crossfader, volume faders)



# Decks

## 1. Transport buttons



**SHIFT:** combined control. For example:

- SHIFT + 1/2: enables a loop by choosing the in point.
- SHIFT + LOOP: enables Vinyl (Scratch) mode.

**SYNC:** enables or disables automatic synchronization of the BPM (beats per minute) values of two tracks.

- SHIFT + SYNC:
  - In DJUCED®: makes the deck the master synchronization (Master Sync) deck.
  - In Serato DJ Lite: disables synchronization on the deck.





**CUE:** inserts a Cue point in the track to identify a specific instant, or moves the deck playhead to the Cue point's position.

- Track paused: inserts a Cue point at the spot where the track is stopped.
- Track playing: stops playback of the track and moves the deck playhead to the Cue point.
  - In DJUCED<sup>®</sup>, if no Cue point has been defined, pressing CUE stops playback and places a Cue point at the playhead's location.
  - In Serato DJ Lite, if no Cue point has been defined, pressing CUE stops playback and places a Cue point at the beginning of the track.
- CUE + PLAY: moves the playhead to the Cue point and plays the track from that point.
- SHIFT + CUE:
  - In DJUCED<sup>®</sup>: moves the playhead to the start of the track, and stops playback.
  - In Serato DJ Lite: moves the playhead to the start of the track, and starts playback.

**Play/Pause:** plays or pauses the track.

- SHIFT + PLAY: in Serato DJ Lite, moves the playhead to the Cue point and plays the track from this marker.



## 2. *Tempo fader*



**Tempo fader:** sets the track's playback speed by adjusting the number of BPM.

- Move up: slows down the track.
- Move down: speeds up the track.
- Tempo fader in the middle: the track's original speed. The green LED is lit up.

When the Beatmatch Guide function is enabled, the TEMPO visual guides indicate whether you need to move the tempo fader up or down, in order to slow down or speed up the track. When the two red arrows are off, the tempo on that deck is identical to the tempo on the other deck.

For more information on the Beatmatch Guide function, please read the [Beatmatch Guide](#) section on page 22.



In Serato DJ Lite and Serato DJ Pro, when Sync mode is enabled, pressing SHIFT and moving the tempo fader at the same time lets you move the tempo fader's values while maintaining the amplitude.

For example, with a tempo scale of  $\pm 8\%$ , or 16% amplitude, you can move the tempo fader's values to cover from 0% (maximum) to -16% (minimum), which still results in 16% amplitude, with -8% in the center.

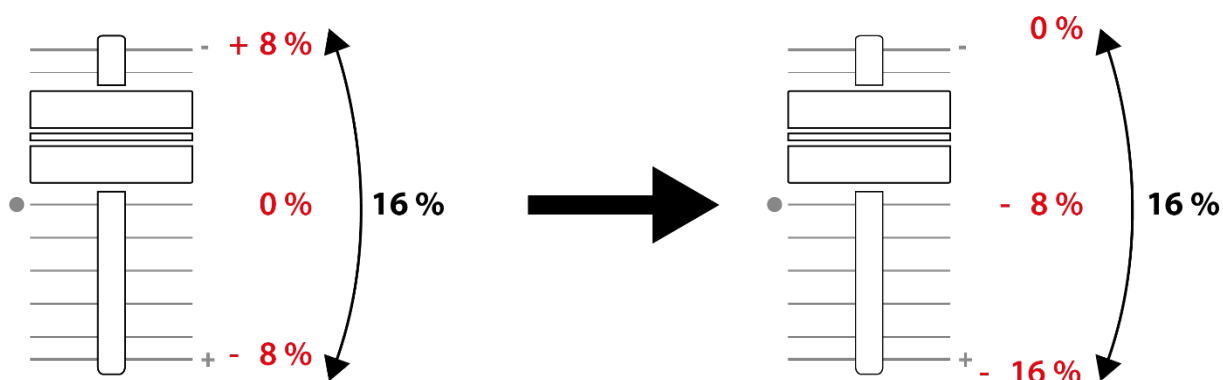



### 3. Loop controls



**LOOP:** enables or disables playback of the loop.

**1/2 / X2:** divides by two or multiplies by two the size of the active loop.

- SHIFT + 1/2 (LOOP IN): enables a loop by choosing the in point.
- SHIFT + X2 (LOOP OUT): enables a loop by choosing the out point.

When the loop is active:

- SHIFT + 1/2: turn the jog wheel to move the start of the loop. To set this start of the loop, press SHIFT + 1/2 again.
- SHIFT + X2: turn the jog wheel to move the end of the loop. To set this end of the loop, press SHIFT + X2 again.

To exit the loop, press LOOP.



## 4. Jog wheel



**Jog wheel:** lets you move within the track, modify the track's playback, and scratch.

When the Beatmatch Guide function is enabled, the BEAT ALIGN visual guides indicate the direction in which you need to turn the ring (i.e. the edge) of the jog wheel in order to align the beat grids of the two tracks. When the two red arrows are off, the beat grids are aligned.

For more information on the Beatmatch Guide function, please read the [Beatmatch Guide](#) section on page 22.



The action carried out depends on three criteria:

- Vinyl (Scratch) mode enabled or disabled;
- track playing or paused;
- the spot where you are touching the jog wheel (top or ring).

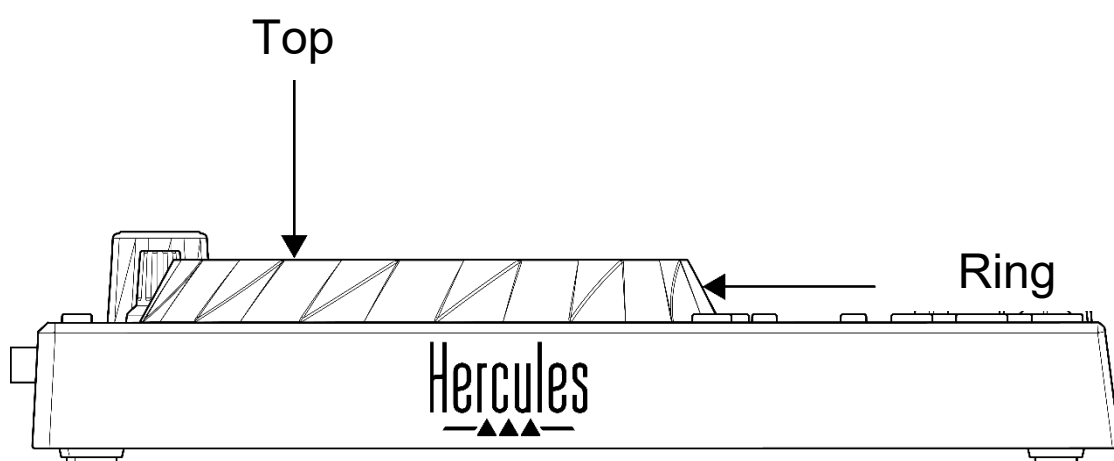

To enable Vinyl (Scratch) mode, press SHIFT and LOOP at the same time. To make sure that Vinyl mode is enabled, press SHIFT. The LOOP button is lit up.



Actions of the jog wheels with Serato DJ Lite and Serato DJ Pro:

Vinyl mode	Play/Pause	Jog wheel	SHIFT button
Scratching			
Enabled	Play	Top	-
Enabled	Pause	Top	-
Disabled	Pause	Top	-
Speed up or slow down playback			
Disabled	Play	Top or ring	-
Move slowly within the track			
Disabled	Pause	Ring	-
Move quickly within the track			
Enabled	Play	Top or ring	Press and hold
Enabled	Pause	Top or ring	Press and hold
Disabled	Play	Top or ring	Press and hold
Disabled	Pause	Top or ring	Press and hold



## Actions of the jog wheels with DJUCED®:

Vinyl mode	Play/Pause	Jog wheel	SHIFT button
Scratching			
Enabled	Play	Top	-
Enabled	Pause	Top or ring	-
Speed up or slow down playback			
Enabled	Play	Ring	-
Disabled	Play	Top or ring	-
Move quickly within the track			
Disabled	Pause	Top	-
Move very quickly within the track			
Enabled	Play	Ring	Press and hold
Enabled	Pause	Ring	Press and hold
Disabled	Play	Ring	Press and hold

DJUCED®





## 5. Pads and modes

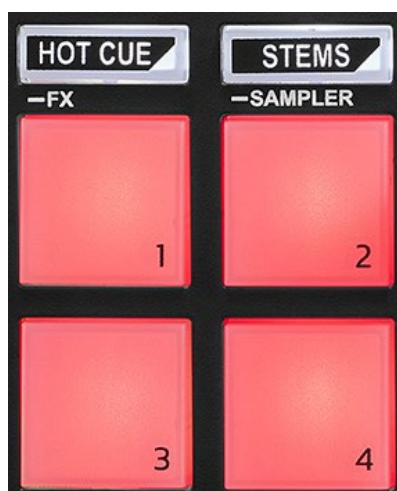

**Mode buttons:** let you enable up to four modes.

To enable a main mode, press HOT CUE or STEMS.

To enable a secondary mode (FX and SAMPLER), simultaneously press SHIFT and HOT CUE or STEMS.

The mode button flashes.

For more information about the different modes with DJUCED<sup>®</sup>, Serato DJ Lite and Serato DJ Pro, please read the [Modes and pads](#) section on page 34.

**Performance pads:** a pad performs an action.



## Mixing

### 6. Track selection controls



**LOAD\***: loads the selected track on the destination deck.  
In DJUCED<sup>®</sup>, collapses or expands folders.

**BROWSER encoder**: lets you browse through your music library by turning the encoder to the left (up) or to the right (down).

Press the encoder to select folders and files.

In DJUCED<sup>®</sup>, press SHIFT and the encoder to return to the root of your music library.

*\*The functionality is identical on decks 1 and 2.*



## **Illuminated ring:**

- In DJUCED<sup>®</sup>, shows the energy level of the master track for the tempo.
- In Serato DJ Lite, shows the rhythm. The light flashes to the beat of the track.

## **ASSIST./PREP.:**

- In DJUCED<sup>®</sup>, displays the panel suggesting the best upcoming tracks for your mix.

Press ASSIST./PREP. and turn the encoder to adjust the energy level of the tracks being suggested.

- In Serato DJ Lite, adds the track currently being played to the Prepare list.



## 7. *Mixing section*



**GAIN knob\***: adjusts the gain (i.e. the volume level before the volume fader).

**2-band equalizer (EQ)\***: controls the intensity of the EQ. A knob is associated with each band: HIGH and LOW.

**FILTER knob\***: adjusts the frequency of the dual filter (high-pass and low-pass).

*\*The functionality is identical on decks 1 and 2.*



## 8. Monitoring, volume and Beatmatch Guide



**MASTER volume:** adjusts the volume of the mix being played on your speakers.

**HEADPHONES volume:** adjusts the volume of the headphones output.

**Monitoring:** selects the sound source played on your headphones.

- \*: plays the sound from deck 1 or deck 2.
- MASTER: plays the sound of the mix being played out loud for the audience.

*\*The functionality is identical on decks 1 and 2.*



**BEATMATCH GUIDE:** enables or disables the light guides to adjust the tempo and align the beat grids of the two tracks. There are four red arrows per deck.



DJUCED® defines one of the decks as the master synchronization (Master Sync) deck, and the other as the slave deck. The red arrows only light up on the slave deck, as this deck follows the tempo of the master synchronization deck.

Serato DJ Lite does not define a master synchronization deck. The red arrows light up on both decks.



- TEMPO visual guides: if one of the two red arrows located to the right of a tempo fader is lit up, this means that the tempo (i.e. number of beats per minute) of the track being played on this deck is different than the tempo of the other deck.

The arrows indicate the direction in which you need to move the tempo fader in order to adjust the tempo of the track being played to match the tempo on the other deck.

- Top arrow lit up: move the tempo fader up. This will slow down the tempo.
- Bottom arrow lit up: move the tempo fader down. This will speed up the tempo.
- Arrows not lit up: the deck's tempo is identical to the tempo of the other deck.



- BEAT ALIGN visual guides: if one of the two red arrows located below a jog wheel is lit up, this means that the beats of the track being played on this deck are not aligned with the beats of the other deck.

The arrows indicate the direction in which you need to turn the jog wheel in order to align the beats of the track being played with the beats of the other deck.

- Left arrow lit up: turn the jog wheel clockwise. This speeds up the playback speed.
- Right arrow lit up: turn the jog wheel counterclockwise. This slows down the playback speed.
- Arrows not lit up: the deck's beats are aligned with the beats of the other deck.





## 9. Mixer

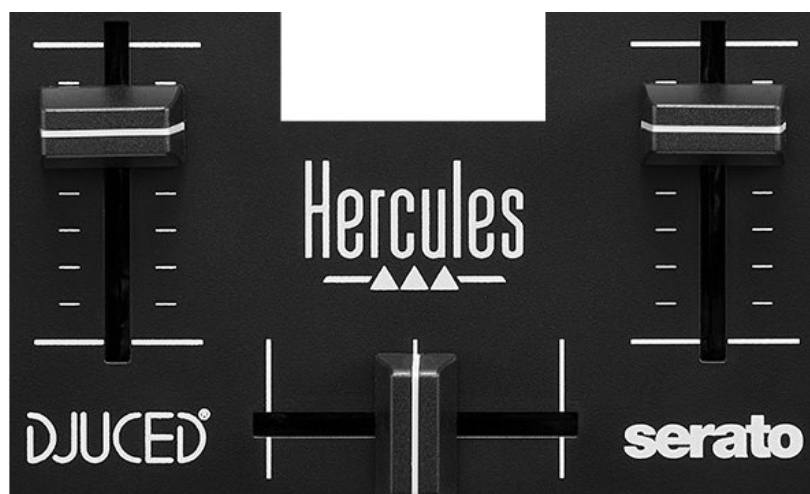

**Volume fader\***: adjusts the deck's volume.

**Crossfader**: lets you make a transition between two tracks by increasing the volume of one of the decks, while decreasing the volume of the other deck.

- Crossfader all the way to the left: you only hear the track on deck 1.
- Crossfader all the way to the right: you only hear the track on deck 2.
- Crossfader in the middle: you hear the tracks on both decks 1 and 2 at the same time.

*\*The functionality is identical on decks 1 and 2.*



## Connectors

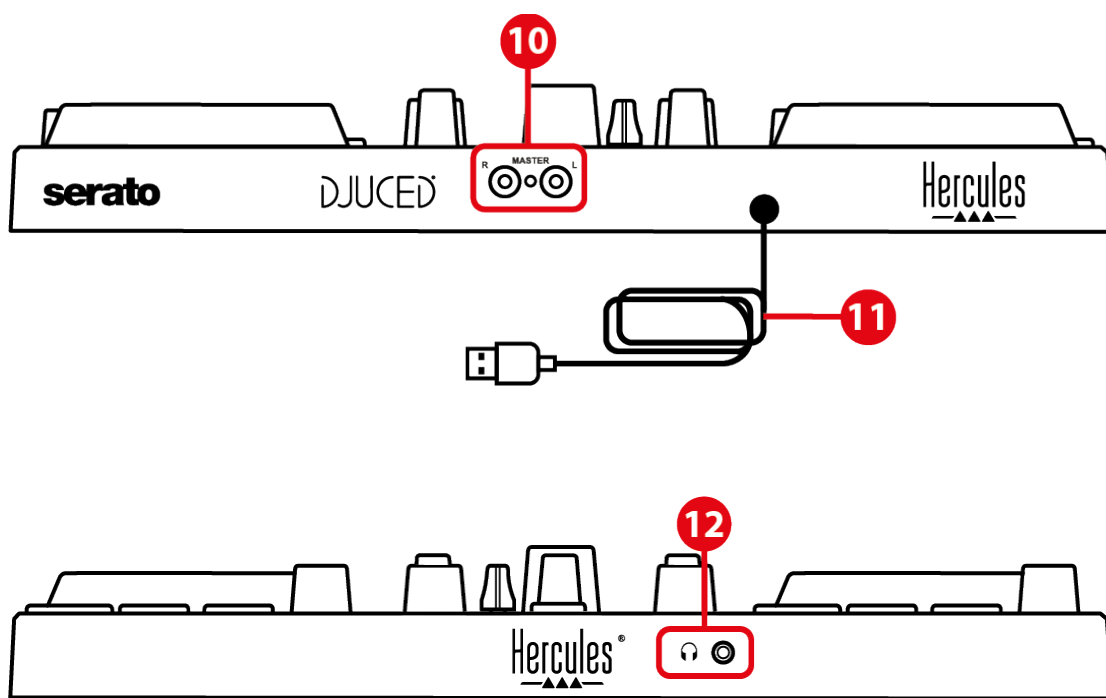

10. Master output for speakers (output 1-2)

11. USB-B 2.0 cable

12. Headphones output (output 3-4)

**Master output for speakers (output 1-2):** lets you connect active speakers.

Format: 2 x RCA (Cinch)

**USB-B 2.0 cable:** lets you connect the controller to a computer.

**Headphones output (output 3-4):** lets you connect headphones in order to monitor tracks.

Format: 3.5 mm stereo mini-jack connector



## 4. Installation

### Connections

1. Connect the DJControl Inpulse 200 MK2 controller to your computer with the USB cable.
2. Connect the inputs on your active speakers to the speaker outputs on DJControl Inpulse 200 MK2 (2 RCA).
3. Connect your headphones to the 3.5 mm stereo mini-jack connector at the front of DJControl Inpulse 200 MK2.

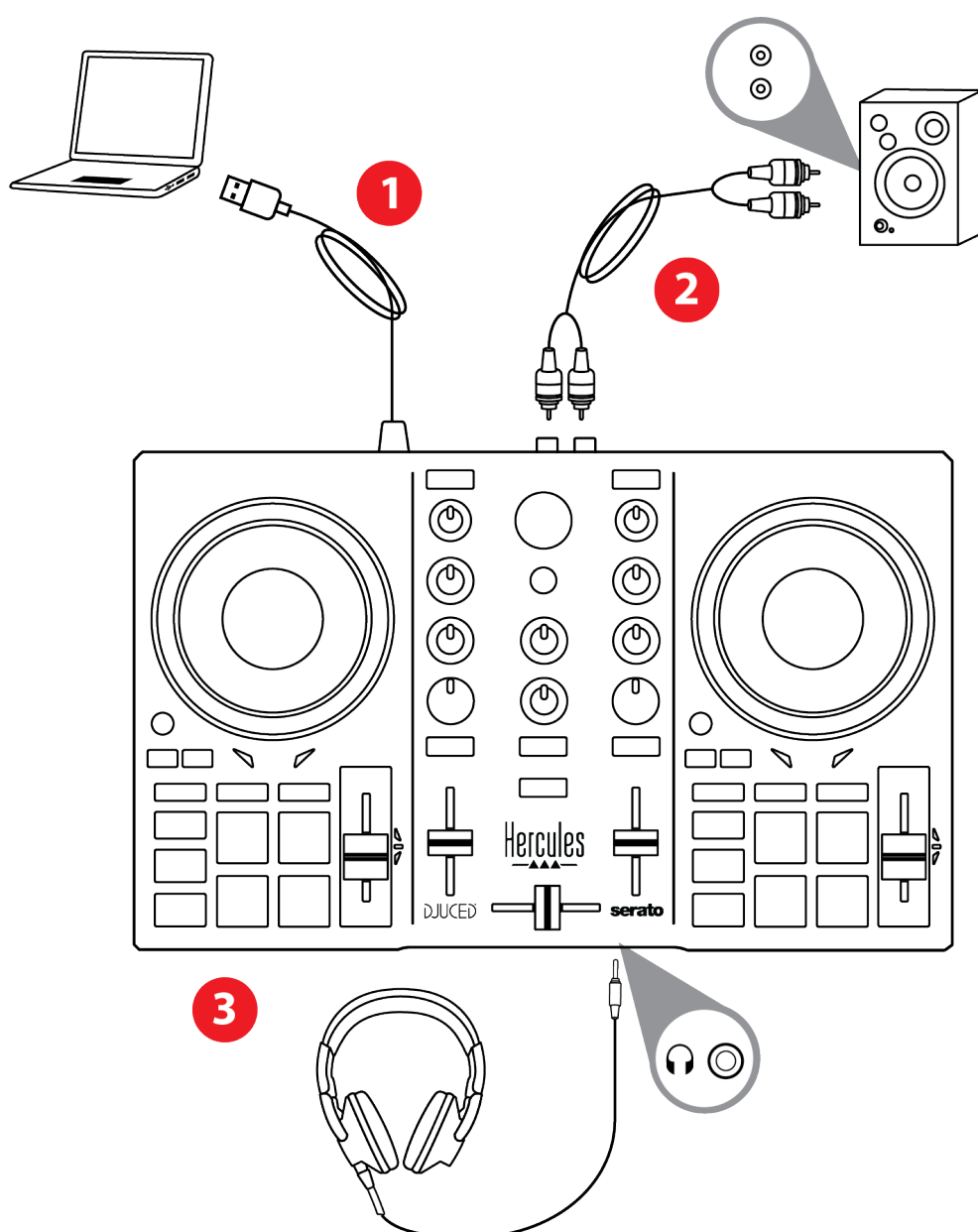



An LED illumination sequence, called Vegas Mode, starts up each time you connect the device to your computer. Vegas Mode takes place in four phases, allowing it to light up all of the LEDs and display different possible colors for the multicolored backlit energy ring.





## Downloading the software

### DJUCED®

1. Please visit: <https://www.djuiced.com/hercules>.
2. Download and install DJUCED®.
3. Please visit:  
<https://support.hercules.com/product/djcontrolinpulse200mk2/>.
4. Download and install the driver pack for your computer's operating system.
  - macOS®: HDJC Series Mac
  - Windows®: HDJC Series PC

Windows® requires that you install the drivers in order to use DJControl Inpulse 200 MK2 in ASIO mode, which reduces the latency compared to WASAPI mode and is generally more stable.

The drivers also let you test your DJControl Inpulse 200 MK2 and verify the firmware version in both Windows® and macOS®.

5. Launch the DJUCED® software. A window appears, indicating that your product has been successfully detected and is ready to use.

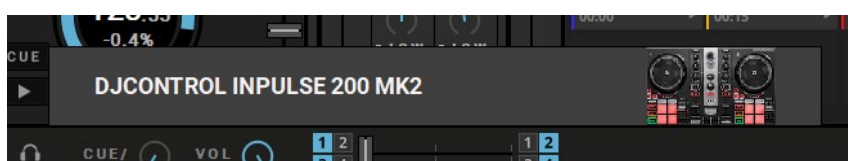



When you run the software for the first time, DJUCED® guides you through connecting your headphones and active speakers (or lets you use the speakers built into your computer, if you don't have external active speakers). Follow the on-screen information step by step before getting started.

### Audio settings:

In DJUCED®, to modify the sound card settings, click the gear wheel icon  in the upper right-hand part of the screen. The Settings menu is displayed.

Select the Audio tab to choose the sound card, and assign the outputs for headphones and speakers.

The standard setup for Windows® is as follows:

- Audio device: DJControl Inpulse 200 MK2 ASIO (ASIO)
- Output:
  - Master: Outputs 1&2
  - Headphones: Outputs 3&4

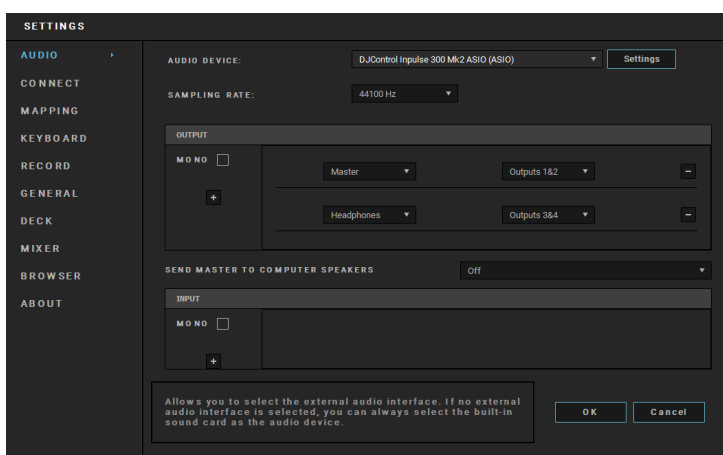



The standard setup for macOS<sup>®</sup> is as follows:

- Audio device: DJControl Inpulse 200 MK2
- Output:
  - Master: Outputs 1&2
  - Headphones: Outputs 3&4

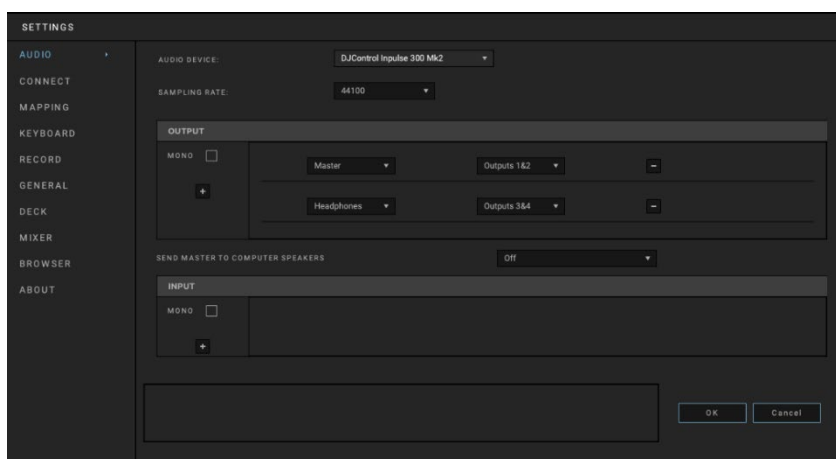

Follow the Hercules DJ Academy tutorials integrated into DJUCED<sup>®</sup>, which you can access by clicking the  icon.

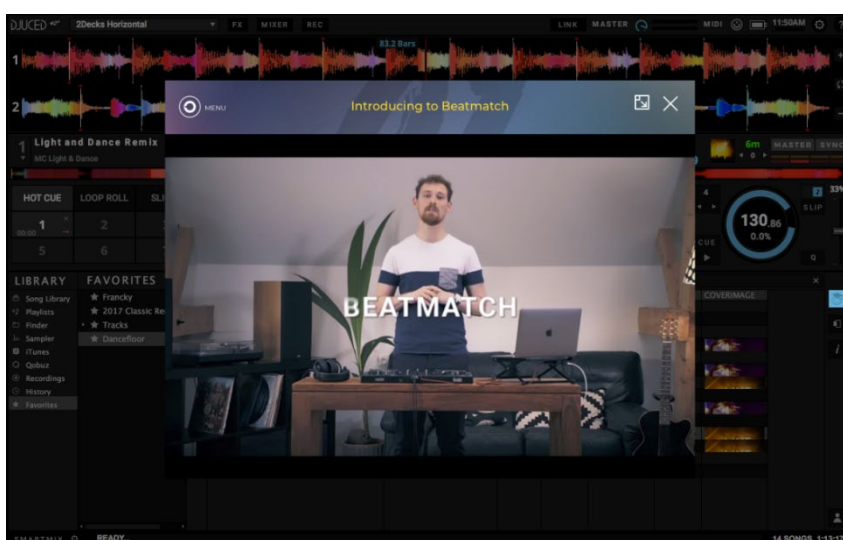

The tutorials are also available [here](#), on the DJUCED<sup>®</sup> YouTube channel.



## ***Serato DJ Lite***

1. Please visit: <https://serato.com/dj/lite/downloads>.
2. Download and install Serato DJ Lite.
3. Please visit:  
<https://support.hercules.com/product/djcontrolinpulse200mk2/>.
4. Download and install the driver pack for your computer's operating system.
  - macOS<sup>®</sup>: HDJC Series Mac
  - Windows<sup>®</sup>: HDJC Series PC

Windows<sup>®</sup> requires that you install the drivers in order to use DJControl Inpulse 200 MK2 in ASIO mode, which reduces the latency compared to WASAPI mode and is generally more stable.

The drivers also let you test your DJControl Inpulse 200 MK2 and verify the firmware version in both Windows<sup>®</sup> and macOS<sup>®</sup>.





Hercules DJControl Inpulse 200 MK2 includes a license for Serato DJ Lite, not a license for Serato DJ Pro. If you install Serato DJ Pro instead of Serato DJ Lite, Serato DJ Pro will work with your DJControl Inpulse 200 MK2 for the duration of a trial period. At the end of this trial period, if you want to continue using Serato DJ Pro, you must purchase a Serato DJ Pro license.



## 5. Livening up your mix

There are different ways to liven up your mix.

### *Modes and pads*

#### *The pads*

Pads 1 to 4 carry out the actions corresponding to the mode currently enabled.

The modes enabled on the pads are the following:

Modes	DJUCED® / Serato DJ Lite / Serato DJ Pro**
1	Hot Cue
2	Stems
3	FX
4	Sampler

**\*\*Serato DJ Pro license not included.**



## ***Hot Cue mode***

A Hot Cue point is a marker (like a bookmark) that you can place in a track to easily locate this moment in the track again, and instantly return to it afterwards.

Four Hot Cue points can be set per track.

1. To access Hot Cue mode, press HOT CUE. The HOT CUE button's light stays lit up.
2. To set a Hot Cue point, press a pad.
3. To play the track from a Hot Cue point, press the corresponding pad.
4. To remove a Hot Cue point, press SHIFT and the pad at the same time.



## ***Stems mode***

Stems mode lets you separate a track into four different parts (vocals and instruments), called “stems”.

1. To access Stems mode, press **STEMS**. The **STEMS** button’s light stays lit up.
2. Pads 1 to 4 are each associated with a stem. To stop playing a stem, press the corresponding pad. The pad’s light turns off.
3. To resume playing the stem, press the corresponding pad. The pad lights up.

Stems:

<b>Deck 1 / Deck 2</b>	<b>Stem</b>
Pad 1	Vocals
Pad 2	Melody
Pad 3	Bass
Pad 4	Drums



## ***FX mode***

FX mode lets you control the effects on the pads. An effect is sometimes a filter or a combination of filters applied to a track to modify its sound (echo, reverb...).

In DJUCED<sup>®</sup>, the pads control the effects rack's effects. To display the effects rack, click .

In Serato DJ Lite and Serato DJ Pro, the pads control four effects that cannot be modified. These effects are not in the Serato DJ effects racks, and consequently you do not see the action of the pads in the software.



1. To access FX mode, press SHIFT and HOT CUE at the same time. The HOT CUE button flashes.
2. To carry out an action, press a pad.

Possible actions:

<b>Deck 1 / Deck 2</b>	<b>DJUCED®</b>	<b>Serato DJ Lite</b>
Pad 1	Effect 1 of the rack	Echo
Pad 2	Effect 2 of the rack	Flanger
Pad 3	Effect 3 of the rack	Reverb
Pad 4	Displays/hides the effects rack	Repeater



## ***Sampler mode***

A sample is a short sound played over the track that is currently playing: it can be played either once or in repetition.

In DJUCED<sup>®</sup>, pads 1 to 4 let you play the four samples found on the first line of the multilayer sampler.

To display the multilayer sampler, select 2Decks Horizontal + 2 Samplers in the drop-down menu in the upper left-hand part of the screen in DJUCED<sup>®</sup>.

In Serato DJ Lite, pads 1 to 4 let you play a sample.

To display the samples panel, click  in Serato DJ Lite.

1. To access Sampler mode, press SHIFT and STEMS at the same time. The STEMS button flashes.
2. To play a sample, press a pad.
3. To stop playing a sample, press SHIFT and the corresponding pad at the same time.



## *Scratching*

Scratching consists of producing a sound effect from a track, by turning the jog wheel.

1. To enable the scratch function, press SHIFT and LOOP at the same time.

In order to ensure that the scratch function (Vinyl mode) is enabled, press SHIFT. The LOOP button is lit up.

2. Place your index finger on top of the jog wheel and make small, quick movements to the right and to the left.

You can repeat this scratch multiple times to create a rhythm.





## *Filters*

Adjustment of the track's filter lets you attenuate certain frequencies.

- Attenuate the high frequencies (known as a low-pass filter or high-cut filter): turn the filter knob (FILTER) to the left.
- Attenuate the low frequencies (known as a high-pass filter or low-cut filter): turn the filter knob (FILTER) to the right.



## 6. Multichannel sound card

The product includes a built-in multichannel sound card, allowing you to play your mix on speakers for the audience (Master output for speakers) and monitor the next track that you're preparing on your headphones (headphones output).

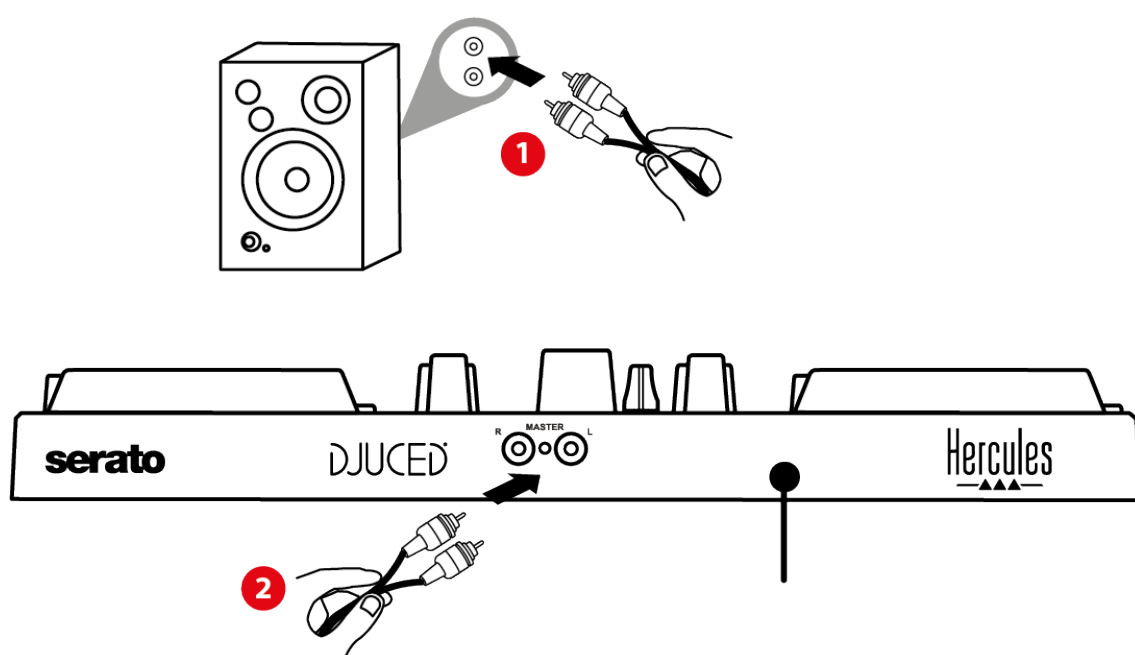

### *Master output for speakers (output 1-2)*

Your active speakers should be connected to the Master output for speakers located at the back of your product.





## *Headphones output (output 3-4)*

Your headphones should be connected to the headphones output   located at the front of your product.

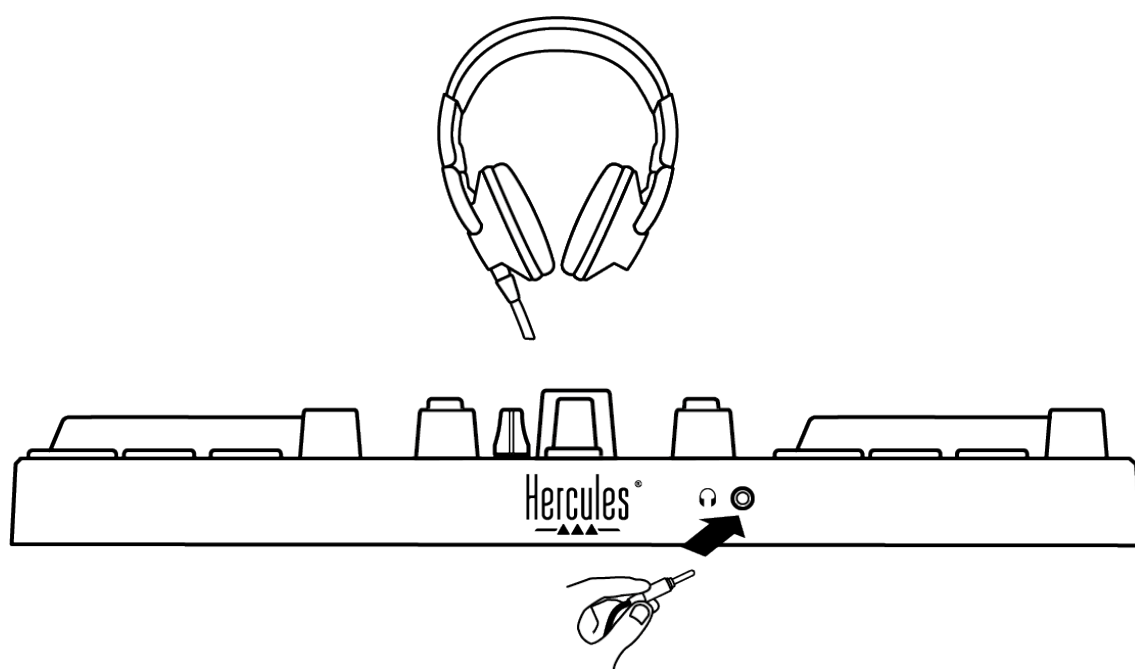

By default, each time your product is connected, the headphones output is assigned to output 3-4 so that it can work with all DJing software available on the market — including DJUCED<sup>®</sup> and Serato DJ Lite, in particular.

However, if you wish to use your product's headphones output to listen to music on your computer using iTunes, for example, you must route output 1-2 to the headphones output. To do this, press the MASTER button.



## 7. Compatibility

### ***USB Audio / USB MIDI***

This product is Plug & Play and can work without drivers on any PC or Mac, as it complies with the USB Audio and USB MIDI standards.

### ***ASIO and Windows® control panel***

To use the DJControl Inpulse 200 MK2 controller with Serato DJ Lite, you must install the ASIO drivers. The ASIO drivers are available here:

<https://support.hercules.com/product/djcontrolinpulse200mk2/>.

If you are using DJUCED®, you can also download the ASIO drivers in order to take advantage of lower latency on your PC.

The ASIO drivers come with a control panel accessible in the taskbar on PC, or in the C:\Program Files\DJHERCULESMIX\Audio\DJ Console Series\ directory. This panel lets you adjust the ASIO buffer size, and thus the latency.

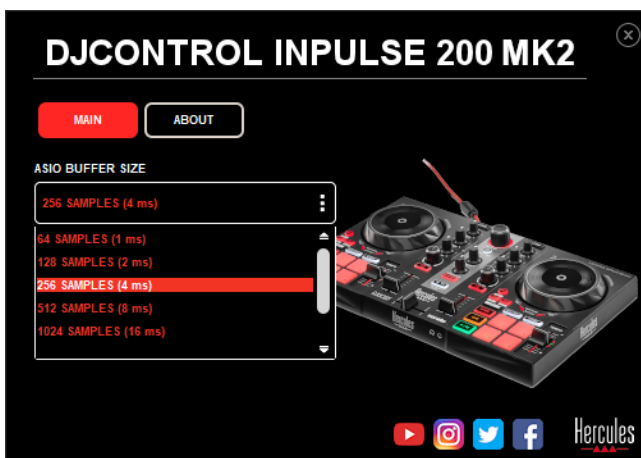

To adjust the ASIO settings:

- Set the ASIO buffer size to 4 or 8 ms.
- Start up your software (e.g.: DJUCED®) and select the DJControl Impulse 200 Mk2 ASIO driver:

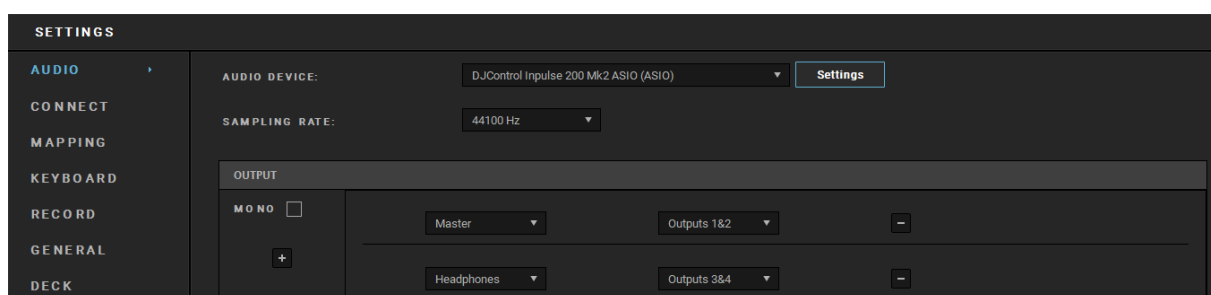

Once the software begins using the ASIO driver, the ASIO settings can no longer be modified in the control panel. This is perfectly normal, and indicates that the ASIO driver is in use.



Use your software and listen for any artifacts, audio glitches (clicks, pops) and latency problems: should any of these issues arise, you will need to adjust the buffer sizes accordingly.

Close your software and adjust your ASIO buffer by one value at a time:

- Reduce the buffer size to reduce latency.
- Increase the buffer size if you notice glitches or artifacts in the audio.

You will need to repeat this procedure until you find the optimal buffer size for your system.

The drivers are available here:

<https://support.hercules.com/product/djcontrolinpulse200mk2/>.



## *Firmware update*

Your product features an automatic firmware update mode. This requires installing the Hercules drivers and following the on-screen instructions. The firmware update will occur automatically.

The drivers are available here:

<https://support.hercules.com/product/djcontrolinputse200mk2/>.

The control panel also allows you to access this information and display the driver versions installed on your computer in the ABOUT tab. Have this information ready if you need to contact Hercules' technical support.

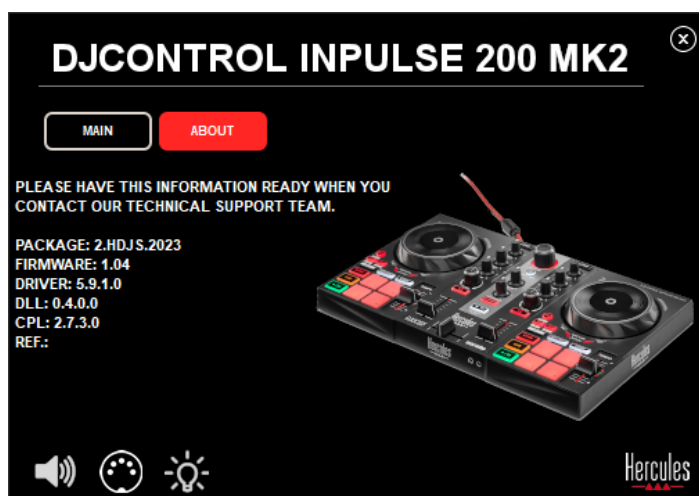



## 8. Demo mode

This mode is available when you connect your product to a USB power supply, and is used in-store, in particular. In this case, the product is not operational but is in demo mode: a demo sequence lighting up the controller's different lights keeps repeating itself.





## 9. FAQs

### 1. *No sound is coming out of my headphones.*

Make sure that you have connected your headphones at the front of the product, as your product is equipped with a multichannel sound card preconfigured to work with DJUCED® and Serato DJ Lite.

By default, the two monitoring buttons are enabled when the software is first launched. You can then select either deck that you want to listen to on your headphones, or use the MASTER button to listen to the results of your mix.



## 2. *The sound on my headphones is distorted.*

Make sure that your headphones feature a TRS connector (standard headphones) and not a TRRS connector (headphones + microphone).

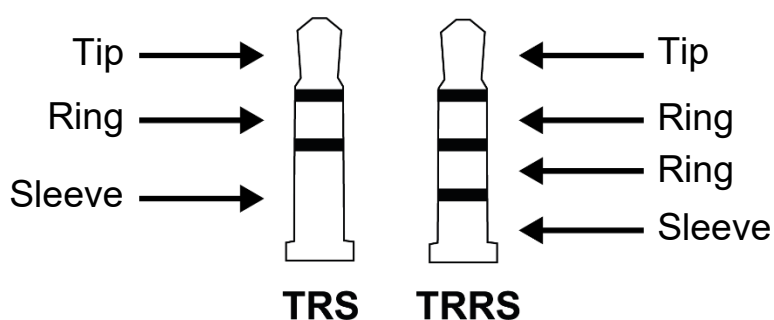

TRRS connectors are not compatible with the DJControl Inpulse 200 MK2 controller.



### 3. *No sound is coming out of my speakers.*

Make sure that you have connected your speakers to the RCA connectors at the back of the product, as your product is equipped with a multichannel sound card preconfigured to work with DJUCED® and Serato DJ Lite.

In order to test (without using DJ software) whether the audio interface of the DJControl Inpulse 200 MK2 controller is producing sound, you can display the DJ controller's control panel. Click the ABOUT tab, and then click the speaker icon. The icon turns green when sound is being played.

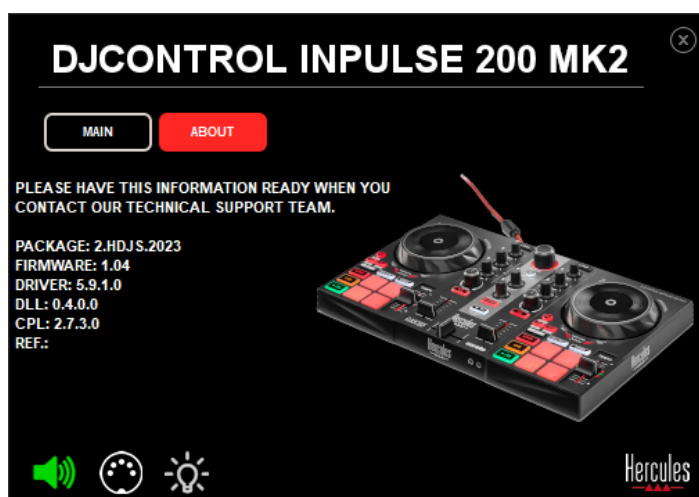



## 4. *No sound is coming out of my laptop computer speakers.*

Your product is equipped with a preconfigured multichannel sound card. If you want to use the speakers built into your laptop computer:

- In DJUCED<sup>®</sup>, access the settings and tick the SEND MASTER TO COMPUTER SPEAKERS option.

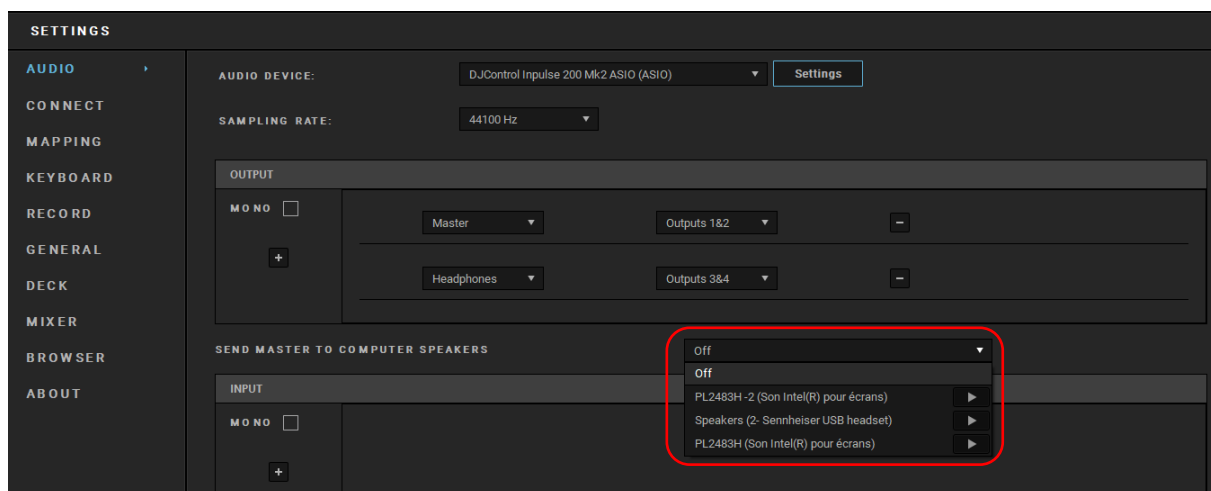

- In Serato DJ Lite, access the settings, open the Audio tab and tick the Use Laptop Speakers option.

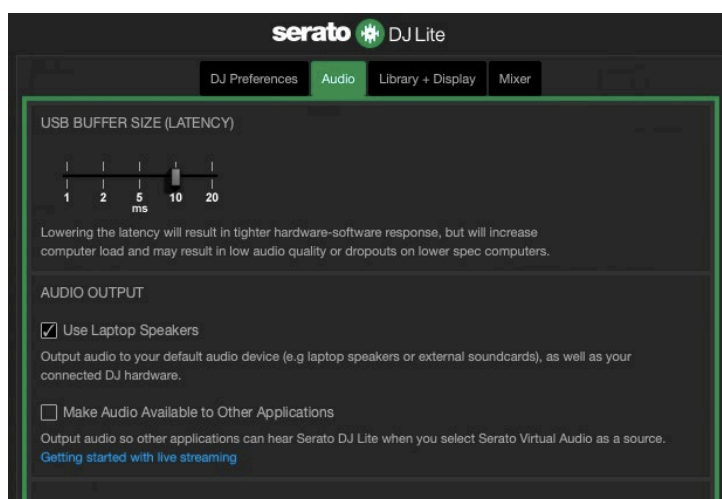



## 5. *No sound is coming out of my headphones, or my laptop computer speakers.*

By default, the sound comes from the Master output for speakers, and the headphones output. It is therefore normal that no sound is coming out of your laptop computer.

If you want to use the speakers built into your laptop computer:

- In DJUCED<sup>®</sup>, access the settings and tick the SEND MASTER TO COMPUTER SPEAKERS option. You must connect your headphones to the DJControl Inpulse 200 MK2 controller.

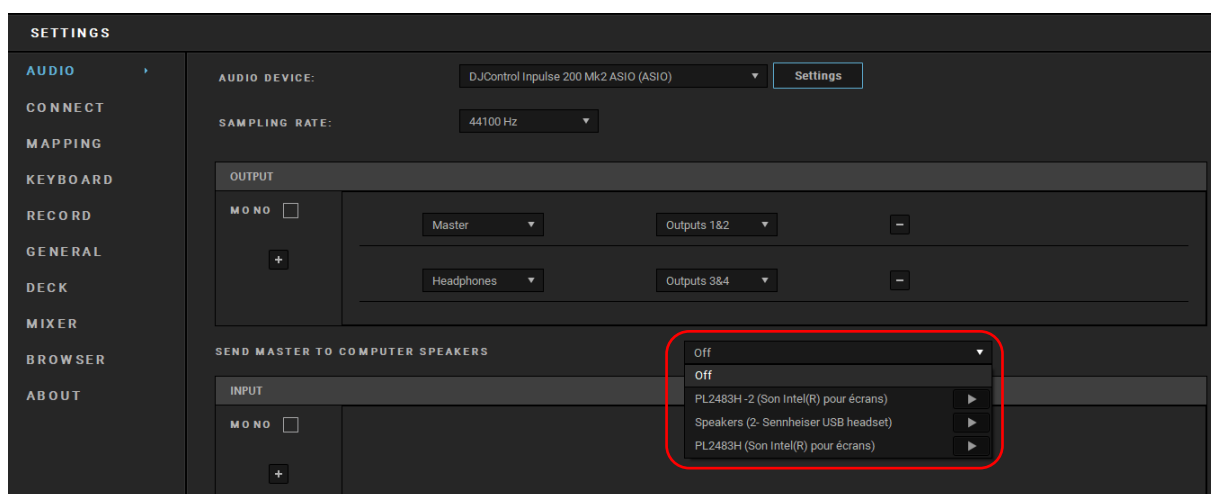



- In Serato DJ Lite, access the settings, open the Audio tab and tick the Use Laptop Speakers option. You must connect your headphones to the DJControl Inpulse 200 MK2 controller.

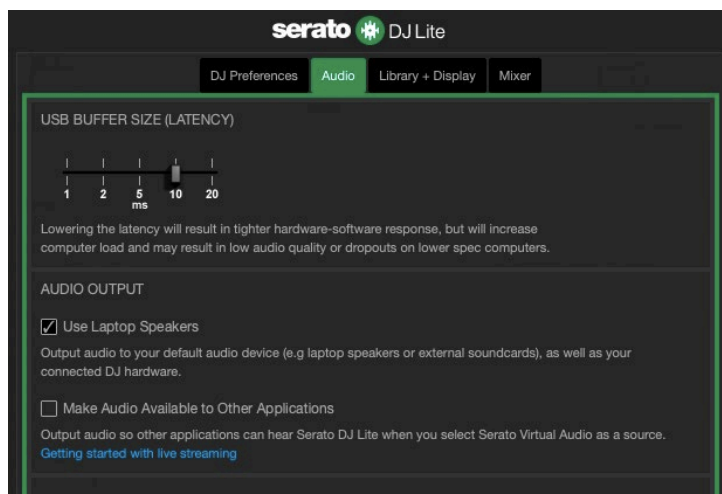

In order to test (without using DJ software) whether the audio interface of the DJControl Inpulse 200 MK2 controller is producing sound, you can display the DJ controller's control panel. Click the ABOUT tab, and then click the speaker icon. The icon turns green when sound is being played.

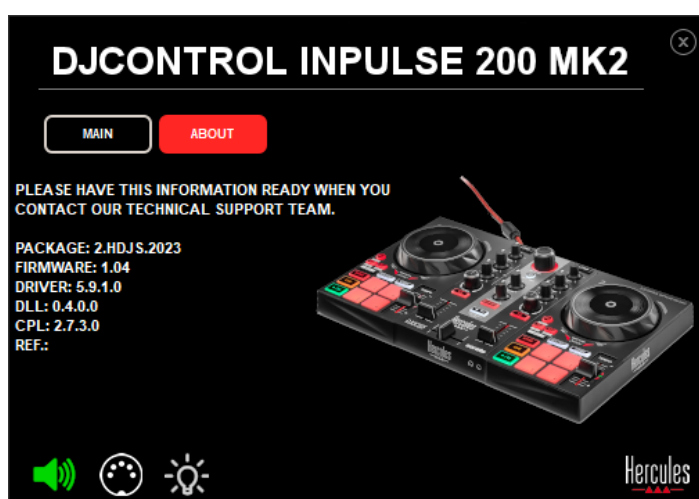



## ***6. I can't connect my multimedia speakers to my DJControl Inpulse 200 MK2.***

If your speakers' connectors differ from the connectors on DJControl Inpulse 200 MK2, you can use a dual RCA to 3.5 mm mini-jack adapter (not included) or any other adapter format corresponding to your speakers.

You can also connect your speakers to the headphones output and route output 1-2 to output 3-4 by pressing the MASTER button.

## ***7. Is the DJControl Inpulse 200 MK2 controller compatible with an iPad or iPhone?***

No, the DJControl Inpulse 200 MK2 controller is not compatible with an iPad or iPhone. It only works with a PC or Mac.



Hercules

TECHNICAL SUPPORT

<https://support.hercules.com>







# Trademarks

Intel® and Intel Core™ are trademarks or registered trademarks of Intel Corporation.

Microsoft® Windows® 10/11 is a registered trademark or trademark of Microsoft Corporation in the U.S. and/or in other countries.

Mac® and macOS® are trademarks of Apple Inc., registered in the U.S. and other countries.

Serato, Serato DJ Lite and Serato DJ Pro are registered trademarks of Serato Audio Research Limited.

The DJUCED® brand and DJUCED®'s graphic elements are the property of Guillemot Corporation.

ASIO is a trademark of Steinberg Media Technologies GmbH.

All other trademarks and trade names are hereby acknowledged in this document and are the property of their respective owners. Illustrations not binding. Contents, designs and specifications in this document are subject to change without notice and may vary from one country to another.



## Copyright

No part of this manual may be reproduced, summarized, transmitted, transcribed, stored in a retrieval system, or translated into any language or computer language, in any form or by any means, electronic, mechanical, magnetic, manual, via photocopying, recording, or other, without the express written consent of Guillemot Corporation S.A.



# DJUCED<sup>®</sup> and Serato DJ Lite End User License Agreement

Please read the License Agreement displayed during installation of DJUCED<sup>®</sup> and Serato DJ Lite carefully.