

WAE Outdoor Rush

Wireless Audio Experience

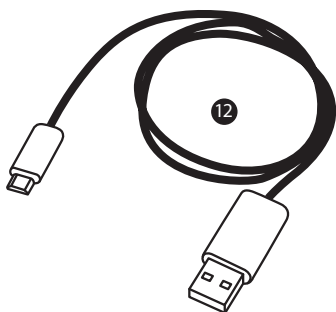
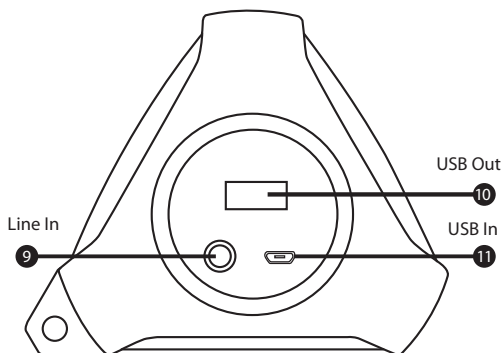
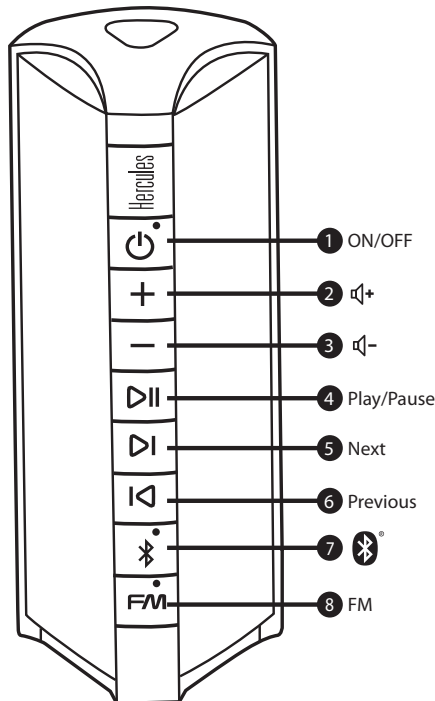

1. On/off button and charge indicator
2. Volume + button
3. Volume - button
4. Play/Pause/Mute button
5. Next button
6. Previous button
7. Bluetooth® button and indicator
8. FM Radio button and indicator
9. Line input connector
10. USB port
11. Micro-USB port
12. Micro-USB to USB cable

1. Charge completely before first use

Completely charge your WAE Outdoor Rush speaker before using it for the first time. Connect the Micro-USB connector on the Micro-USB to USB cable (12) to the Micro-USB port (11) on the WAE Outdoor Rush speaker, and the other end of the cable to the USB port on a computer or on a smartphone/tablet USB power adapter (5V/1A)*.

The standard charging time is 3.5 hours.

While charging, the charge indicator (1) flashes green. When the battery is fully charged, the charge indicator (1) stops flashing.

When the battery level is low, the charge indicator (1) flashes.

2. Getting started with your speaker

To power on your WAE Outdoor Rush speaker, press the on/off button (1). To power off the speaker, press the on/off button (1) for 2 seconds.

When used for the first time, your WAE Outdoor Rush speaker is ready for pairing: the Bluetooth® indicator (7) flashes blue.

- On your smartphone/tablet, MP3 player or computer, enable the Bluetooth® wireless technology function, and search for available Bluetooth® devices.

- Select WAE Outdoor Rush in the list of available Bluetooth® devices and carry out the pairing (if an access code is required, enter 0000).

Once the devices are paired and connected, the Bluetooth® indicator (7) stays lit up in blue. You are now ready to play your music.

3. Volume and music controls

The volume + and volume - buttons (2 and 3) let you control the volume of your WAE Outdoor Rush speaker, independently of the controls on your Bluetooth® device (smartphone, tablet, MP3 player, computer...).

For devices supporting Absolute Volume (AVRCP 1.4) mode, their volume level is directly controlled by the WAE Outdoor Rush speaker.

4. Playing music on the WAE Outdoor Rush from another music source

If you want to play music from a different Bluetooth® music source (smartphone, tablet, lecteur MP3, PC...) than that currently used, press and hold the Bluetooth® button (7) for 3 seconds until it beeps to disconnect the connected device. The Bluetooth® indicator (7) flashes blue to indicate that you can now pair and connect a new Bluetooth® device.

5. Clearing the saved list of paired devices

Your WAE Outdoor Rush speaker can save pairing information for up to 8 devices. A long press (8 seconds) on the Bluetooth® button (7) lets you clear the saved list of paired devices.

6. FM radio

Press the FM Radio button (8) to enable the FM radio function: the FM Radio indicator (8) lights up in white.

When used for the first time, an automatic scan is carried out: the automatic scan will save all detected stations, and will start playing the first station when the scan is complete. You can then switch between the different stations using the Next (5) and Previous (6) buttons.

Pressing the Play/Pause button (4) enables or disables the mute mode.

To launch a new scan for stations, press and hold the FM Radio button (8) for 3 seconds. During a scan, the indicator (8) flashes white. You can save up to 40 stations.

Download and check out all the FM functionalities thanks to the WAE Music app: display frequencies, stations list...

In the US only: in order to improve the quality of the FM reception, you need to download and

install the WAE Music app. Once connected to the WAE Outdoor Rush, from the FM panel, go to the advanced settings ⚙️ and change the EU/US setting to US.

7. Line input

You can connect your MP3 player directly to the speaker's line input connector (9).

8. Standby mode

When the WAE Outdoor Rush speaker plays no music (via the Bluetooth® function or the FM radio) for 10 minutes or more, it switches to standby mode in order to save battery power. You can "wake it up" from standby mode by pressing the on/off button (1) or using the WAE Music app.

9. Charging function**

When the Bluetooth® mode is enabled (only in this mode), you can charge your smartphone by connecting it to the USB port (10).

You can reduce the charging time by turning off the Bluetooth® function: to do so, press the Bluetooth® button (7) twice. When your device is fully charged, press the Bluetooth® button (7) twice again to enable the function.

Your WAE Outdoor Rush speaker features a USB port (10), allowing you to charge an external device (smartphone, MP3 player).

The charging power level provided by the speaker is 500 mA, allowing you to charge most smartphones. You cannot use the speaker to charge a tablet.

10. IP67 protection

Make sure that the protective cap is fully screwed on, in order to ensure that the product is water- and dust-tight.

Use the tool attached to the wrist strap to lock/unlock the protective cap.

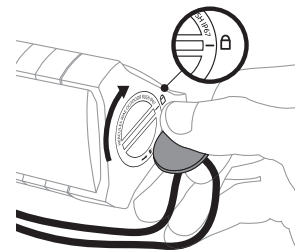

* Not included.

** A specific cable (not included) may be required.

Download the WAE Music app



MAIN PANEL WITH WAE OUTDOOR RUSH SPEAKER CONNECTED

<p>SPEAKER OPTIONS</p>	<p>90%</p>	<p>USER MANUAL</p>
<p>Access information regarding the app version, firmware version, standby mode, etc.</p>	<p>Information regarding the WAE Outdoor Rush speaker's battery level.</p>	<p>Access the online manual.</p>
<p>MUSIC PLAYER</p>	<p>AUTO SCAN</p>	
<p>Open the music player.</p>	<p>Scan for the WAE Outdoor Rush speaker when the connection has been lost. This button is only available when the connection has been lost.</p>	
<p>SOUND SETTINGS</p>	<p>STANDBY</p>	<p>FM</p>
<p>Open the equalization panel (in <i>Bluetooth®</i> mode only).</p>	<p>Remotely turn on the WAE Outdoor Rush speaker/put it in standby mode. Standby mode affects the speaker's battery life.</p>	<p>Open the FM control panel.</p>

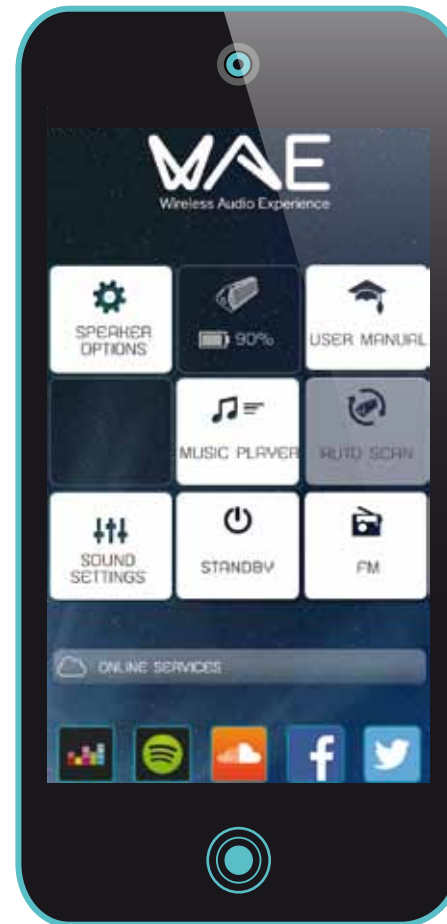

Main panel

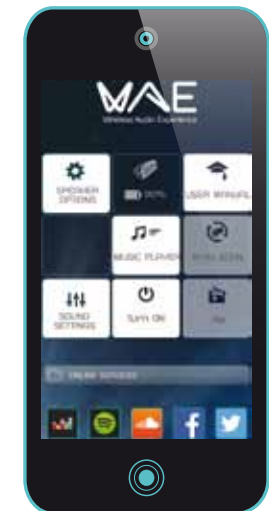

Main panel in standby mode

FM PANEL

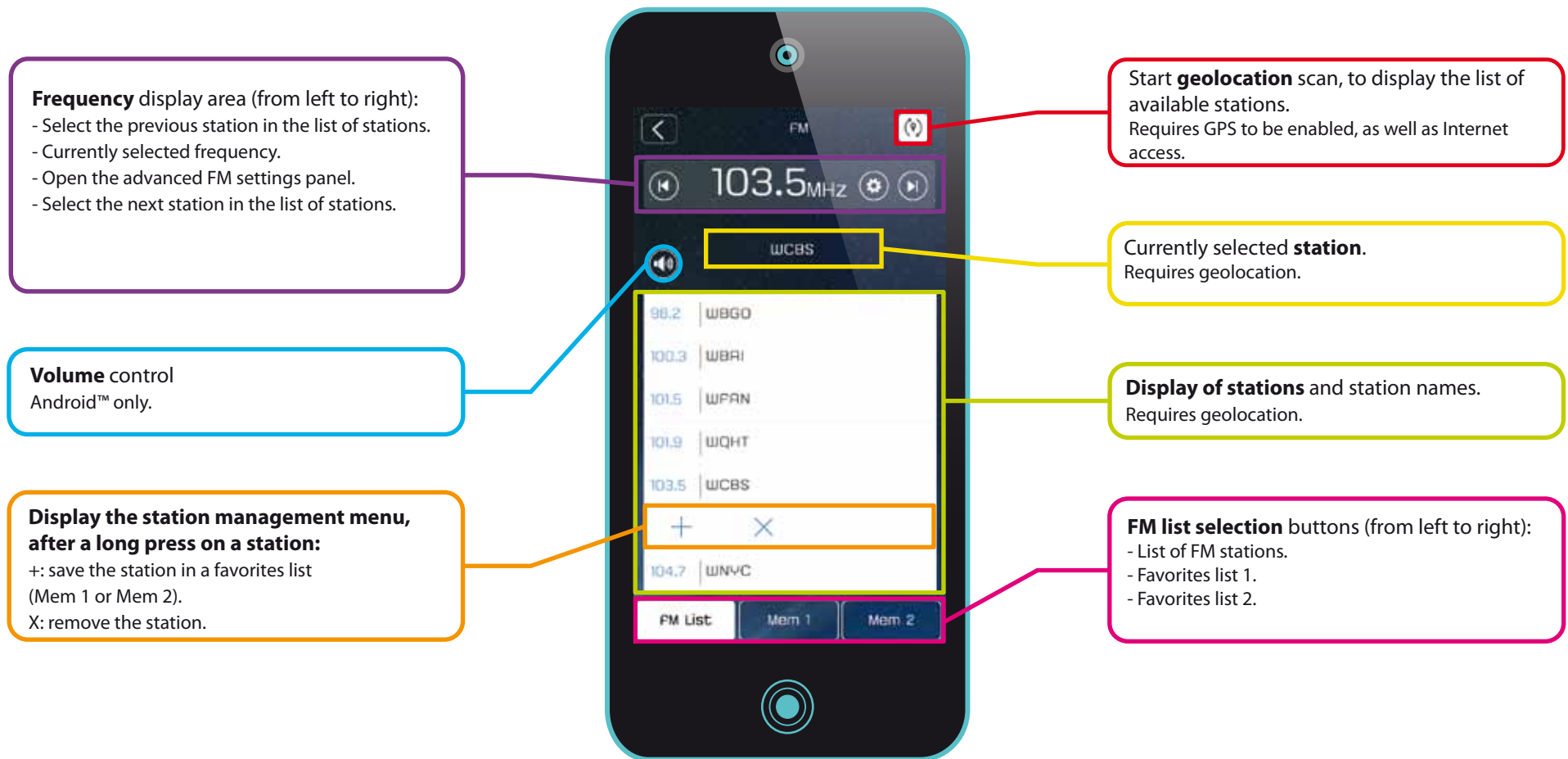

FM PANEL

The image shows a smartphone screen with the 'Speaker's FM settings' interface. The screen displays a frequency of 103.5 MHz, the station name 'WCBS', and an 'FM Save' button. Below this, there are 'EU/US Settings' with 'EU' and 'US' options, and a toggle for 'Automatic frequency update of your favorite stations via geolocation feature'. Colored callout boxes point to these elements: a red box for the back button, a yellow box for the search buttons, a blue box for the frequency dial, a green box for the 'FM Save' button, an orange box for the 'EU/US Settings', and a pink box for the automatic update toggle.

Back button, to **return to the previous panel** (in iOS).
Use the ↩ Back button in Android.

Automatically search for a station before or after the currently selected frequency.

Manually select a frequency.

Save the station.

Select the speaker's **FM settings**:
Europe or US.
A new geolocation scan is required each time this setting is changed.

Enable/disable **automatic frequency updating** of your favorites lists during a geolocation scan.

Advanced FM settings